Intelligent Traffic Light Controller for Ambulance

**Dr. P. Sankar Babu^{1*}, K. Meenendranath Reddy², S. Vijaya Lalitha³,
P. Naga Timmaiah⁴, V. Srikanth⁵**

^{1*}Professor, Department of EEE, SVR Engineering College, Nandyal, Andhra Pradesh, India.

^{2,3,4}Assistant Professor, Dept. of EEE, SVR Engineering College, Nandyal, Andhra Pradesh, India.

⁵M. Tech, SS Infotech, Hyderabad, India.

Corresponding Email: ^{1*}kvmsvr@gmail.com

Received: 06 July 2023 **Accepted:** 22 September 2023 **Published:** 08 November 2023

Abstract: *The recent surge in car numbers has led to a dramatic increase in gridlock. Due to this, several individuals have perished while ambulances did not arrive in time. The primary goal of any rescue vehicle is to get there as fast as possible without compromising safety. Every second lost waiting at a red light or stuck in traffic decreases the likelihood of making it to safety. Because of this, it is crucial that emergency vehicles, such as ambulances, be given signal priority so that they may move quickly through congested areas. The reaction time of rescue vehicles is decreased and traffic flow is enhanced thanks to this innovation.*

Keywords: *Arduino, Power Supply, ESP 8266, RFID, LED.*

1. INTRODUCTION

The congestion that plagues our modern society is a major source of frustration for everyone. Congestion is bad enough, but this adds a significant obstacle to the ability rescue vehicles to do their jobs. While it is imperative that rescue vehicles be given the highest priority on the road, this is not always the case. Sometimes this is due to unforeseen circumstances, and other times it is because drivers are too focused on themselves. If rescue vehicles are delayed, lives might be at danger.

There has to be some kind of technology that can anticipate the appearance of a rescue vehicle at a busy intersection and divert traffic in its path. This might reduce waiting times and help those in need more quickly. However, many nations, including India, do not take effective efforts to address this issue. Therefore, either the signal can be ignored or emergency vehicles can continue to operate legally. There is a considerable risk of collisions if emergency vehicles ignore the traffic light. IoT is the result of recent technological advancements and

offers a practical solution to these problems. Using an ATC system, emergency vehicles can bypass the problems they often encounter.

Each lane at a given intersection is equipped with a smart object that listens for an emergency vehicle's siren, activating a camera to take a picture, and then checking to see if it matches a database of known emergency vehicles. Once the vehicle's status as a rescue vehicle has been confirmed, the signal is sent on to the Decision Making System. When an emergency vehicle is detected, the Decision Making System directs traffic to make way for it. The other traffic signals at that intersection are all flashing red. After the emergency vehicle has been identified using sound detection sensors and has left the area, the traffic signals are reset. Latency is avoided since the rescue vehicle is located before it arrives. Decision Support uploads traffic records to a remote server.

System Components

A. Power Supply

The purpose of these power supplies is to reduce the voltage of the AC mains energy so that it may be used by electronic circuits as well as other devices. Each component of a power supply serves a specific purpose and may be analysed independently. The regulated electrical supply takes in alternating current and outputs a stable direct current. See an example of a typical regulating DC power supply's block diagram in the image below.

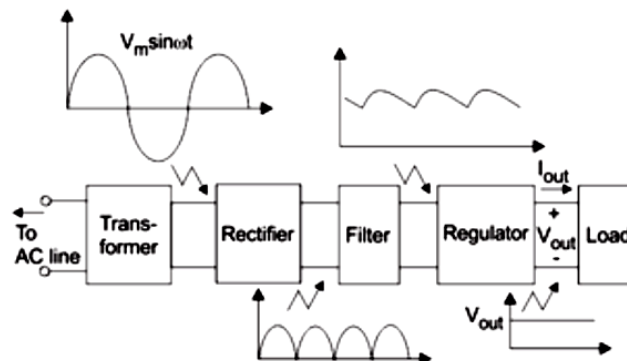

B. ESP 8266

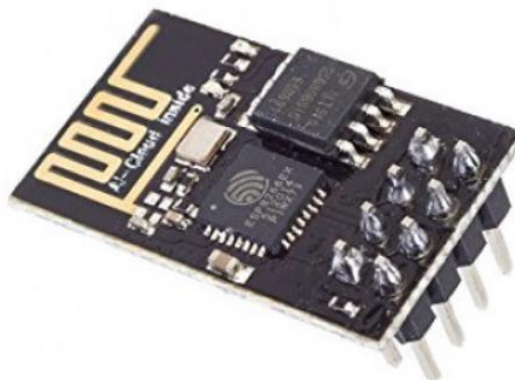

Dramatic Solutions in Shanghai, China produces the ESP8266, a low-cost Wi-Fi microprocessor with a full TCP/IP stack with microcontroller functionality. In August of 2014, the ESP-01 unit by Ai-Thinker, a third-party vendor, brought the chip to the notice of US manufacturers. With this little module, microcontrollers may establish TCP/IP connections across a wireless network with the use of standard Hayes-style instructions. At initially, however, very little information was available in English about the chip & the orders it could understand. Many hackers were drawn to the module, chip, and software, as well as the translation of the Chinese records, because to its low cost with the fact so it had very few outside parts on it, indicating that it may someday be extremely affordable in bulk.

C. Arduino

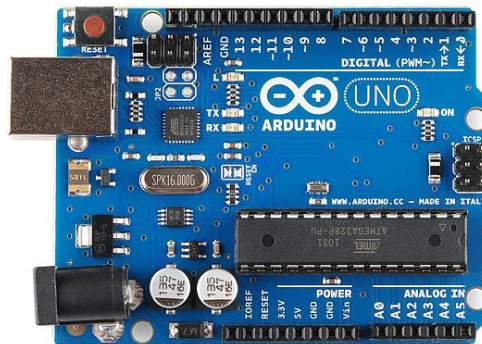

The Arduino Uno is the most widely used board in the Arduino family. When people talk about an Arduino, they usually mean this board. The Uno is a wonderful option for those just getting started with Arduino. There have been several iterations of the Arduino Uno, and we've included information about the most recent one (Rev3 or R3) below. The Arduino Uno is an ATmega328-based microcontroller board. It is equipped with a reset button, a USB port, a power connector, an ICSP header, and 14 digital I/O pins (6 of which may be utilised as PWM outputs).

D. RFID

RFID is an abbreviation for "radio frequency identification," which explains that the technology relies on radio waves for its functionality. An RFID system, used for automatic item recognition and observing, includes a reader and a tag.



E. Traffic Lights



There are often three signals at a traffic light, containing data conveyed by colour and signs like arrows and bicycles.

F. LED

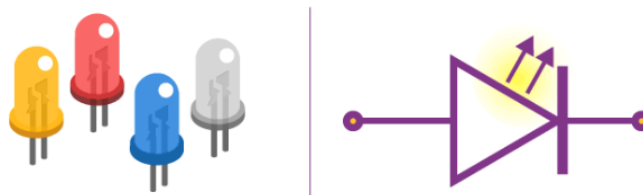

Simple LED circuits use semiconductor diodes that generate light while a current of electricity is passed through them in the forward direction. The p-n junction emits a sort of incoherent, narrow-spectrum light known as electron-luminescence. LEDs are rapidly being employed in more powerful uses like torches and area illumination, in addition to their widespread use as light indicators on electronic gadgets. LEDs typically have optics attached to the chip in order to shape the radiation pattern and aid in reflection, making them a very tiny area (less than 1 mm²) light source. The semi conducting material's structure & quality determine whether the light it produces is visible, infrared, or ultraviolet. UV-LEDs may be used for more than just illumination; they can also be used to disinfect gadgets and water, and as a grow light to boost photosynthesis in plants.

Proposed System

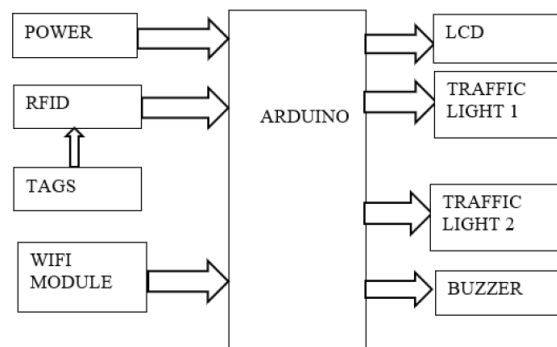

As a result of technical developments, dealing with the growing amount of people and cars on the road has grown more complex and dangerous, and the healthcare business confronts its own special issues in this respect. This causes congestion in the nation's largest cities. Congestion has a negative impact on transport networks in many nations. When there is a major accident on the roadways, the ambulance service is significantly delayed. Patients who are seriously ill or injured who need to go to a hospital as fast as possible are common passengers in ambulances. If the ambulance delays too long to get to the hospital, the patient may not make it. Data show that 95% of heart attacks are treatable if the ambulance gets to the healthcare facility in time during a heart attack. Because of this, drivers must make way for the ambulance on the road. But there are occasions when the ambulance is delayed due to traffic.

2. RESULTS

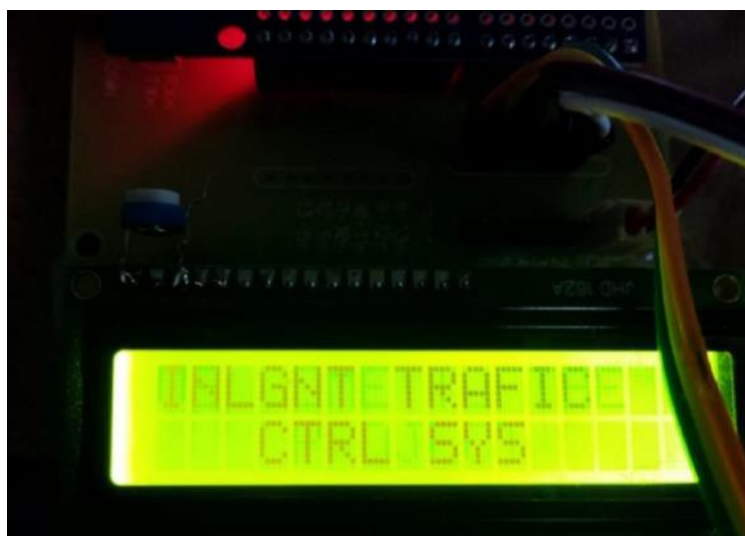
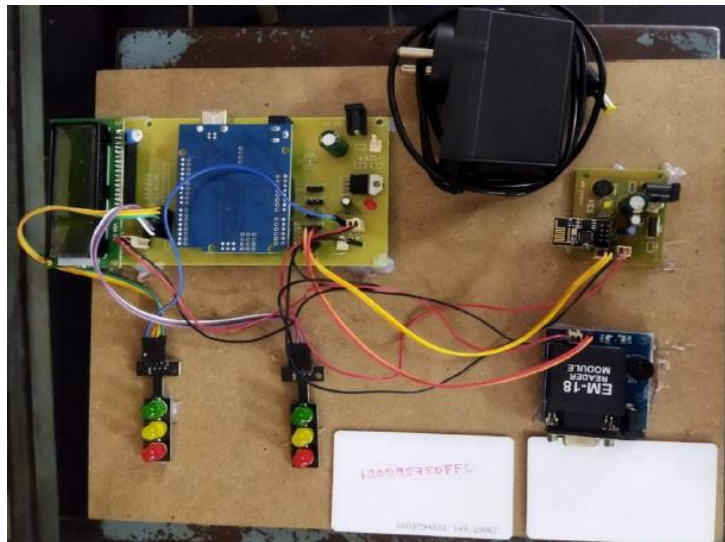

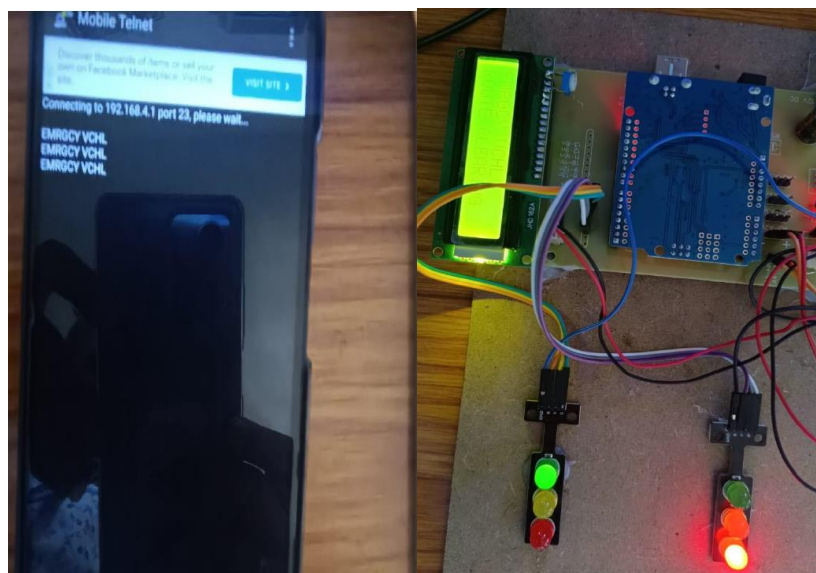
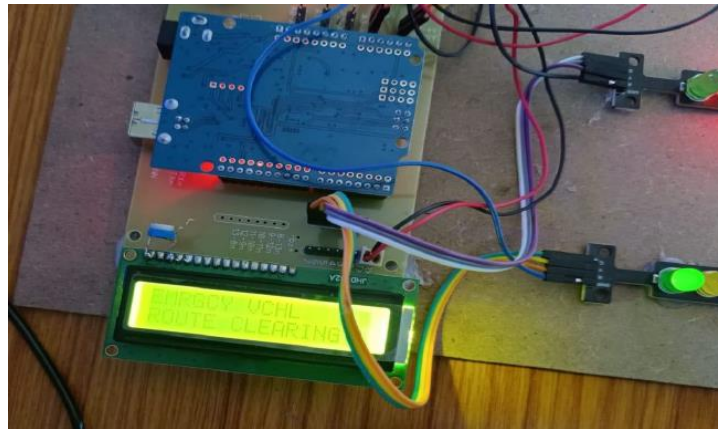

When the input receives the supply. The LCD will be switched on with the project's name shown in the window. And now the machine is functioning well. This diagram illustrates how the project's title will appear on an LCD screen. And the functioning of the traffic signals will be shown.

3. CONCLUSION

The human labour of the road safety officer can be reduced by using digital control of traffic signs that is calibrated to the route's actual traffic volume. There is minimal need for human involvement because the system is fully automated. When a stolen car is detected, the light will turn red so that an officer can intervene, if one exists at the intersection. They will also receive text messages to help them be ready to stop the stolen car at the next intersection. When responding to an emergency, time is of the essence for vehicles such as ambulances and fire engines. They risk endangering many people's lives if they are stuck in traffic for long periods of time. As long as a rescue vehicle is waiting at the intersection after being

given the all-clear, the light will turn green. The light will change to red when the emergency vehicle has passed through. The prototype may be improved upon by testing it with RFID readers that have a greater range. Additionally, GPS may be included into the stolen car detection module. This would allow the precise position of the stolen vehicle to be tracked at all times. The current method takes into account just one of the roads at the intersection. Expanding it to cover every street in a complex intersection is a good idea.

4. REFERENCES

1. Vara prasad G., Wahida Banu R.S.D., “Flexible Routing Algorithm for Vehicular Area Networks”, in Proc. IEEE Conference on Intelligent Transport Systems Telecommunications, Osaka, Japan, pp.30-38, 2010.
2. Go kulan B.P., Srinivasan D., “Distributed Geometric Fuzzy Multi-Agent Urban Traffic Signal Control”, IEEE Transactions on Intelligent Transportation Systems, vol.11, no.3, pp.714-727, 2010.
3. Kumar S., Abhilash P.G., Jyothi D.G., Vara prasad G., “Violation Detection Method for Vehicular Ad Hoc Networking”, ACM/Wiley Security and Communication Networks, 2014, DOI:10.1002/sec.427.
4. ADOOS M., Mahayana N and Bazan A.L.C., “Traffic Light Control in Non- Stationary Environments based on Multi agent Q-learning”, in- Proc. IEEE Conference on Intelligent Transportation Systems, pp.580- 1585, 2011.
5. ZigBee Alliance, “ZigBee Specifications”, IEEE Standards 802.15.4k2013, <http://www.zigbee.org/Specifications.aspx>.
6. Ayush K.R. Mittal, Deepika Bhandari, “A Novel Approach to Implement Green Wave system and Detection of Stolen Vehicles”, in Proc. IEEE Conference on Advance Computing, pp.1055-1059, 2013.
7. Suresh Sharma, Alok Pit hora, Gaurav Gupta, Mohit Goel, Mohit Sinha, “Traffic Light Priority Control For Emergency Vehicle Using RFID”, International Journal of Innovations in Engineering and Technology, vol.2, no.2, pp.363-366, 2013.
8. Rashmi Hegde, Rohith R. Sali, Indira M.S., “RFID and GPS based Automatic Lane Clearance System for Ambulance”, International Journal of Advanced Electrical and Electronics Engineering, vol.2, no.3, pp.102-107, 2013.
9. Vara prasad G., “High Stable Power Aware Multicast Algorithm for Mobile Ad hoc Networks”, IEEE Sensors Journal, vol.13, no.5, pp.1442-1446, 2013.